

200 SERIES

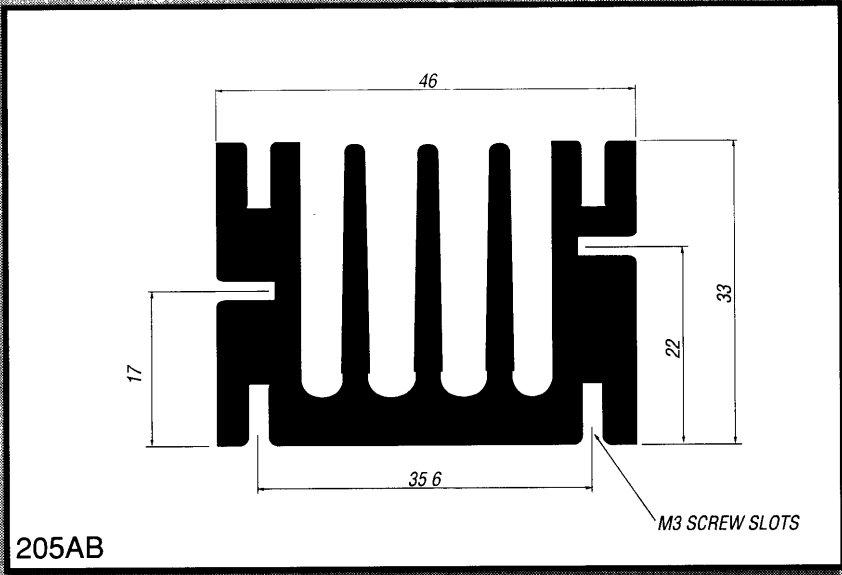

Typical Performance		°k/w Black				
Length		50	75	100	150	200
°k/w		4.90	3.80	3.40	3.25	3.15

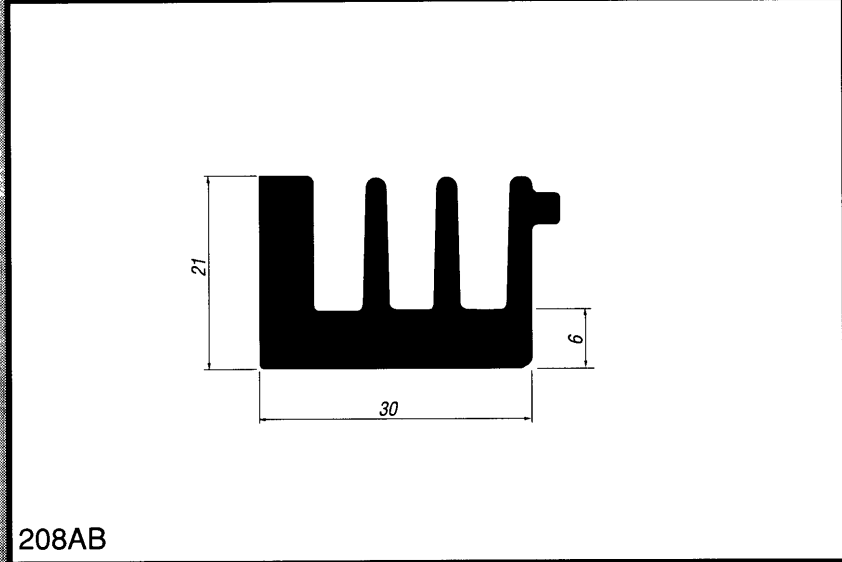
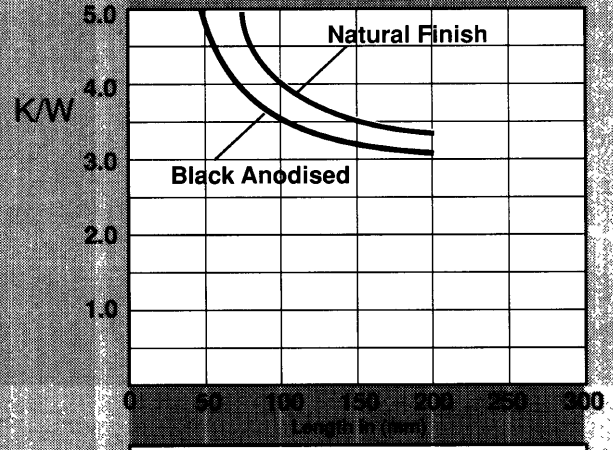

Typical Performance		°k/w Black				
Length		50	75	100	150	200
°k/w		9.00	6.50	5.30	4.30	4.00

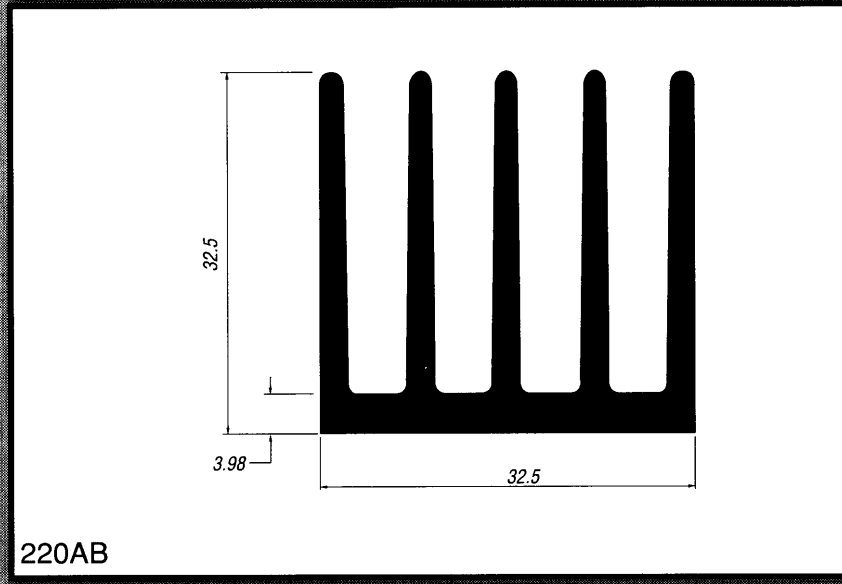
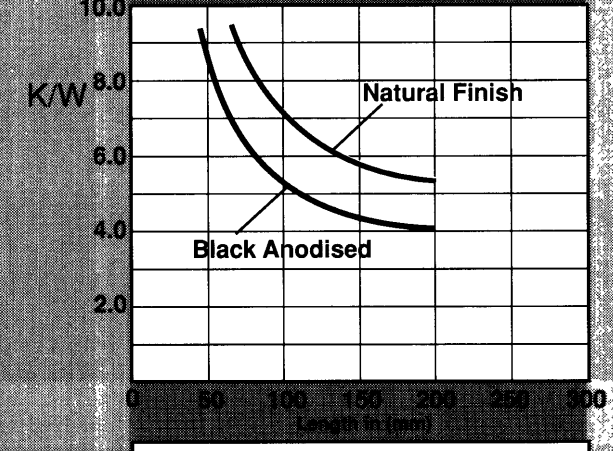

Typical Performance		°k/w Black				
Length		50	75	100	150	200
°k/w		6.00	4.80	3.90	3.00	2.50

