

# TOPJOB<sup>®</sup>S

## Reihenklemmen 6 (10) mm<sup>2</sup>

### Serie 2006

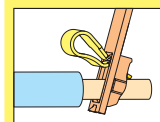

1  
9

<b>0,5 – 6 (10) mm<sup>2</sup> ①</b> 800 V/8 kV/3 41 A Klemmenbreite 7,5 mm / 0.295 in 13 – 15 mm / 0.55 in *  CCA LR	<b>AWG 20 – 8</b> 600 V, 50 A 600 V, 50 A	<b>0,5 – 6 (10) mm<sup>2</sup> ①</b> 800 V/8 kV/3 41 A Klemmenbreite 7,5 mm / 0.295 in 13 – 15 mm / 0.55 in *  CCA LR	<b>AWG 20 – 8</b> 600 V, 50 A 600 V, 50 A	<b>Reduzierbrücken</b> Generell ist zu beachten: <b>Der Summenstrom der Abgänge darf den Nennstrom des Reduzierbrückers/Kammbrückers nicht überschreiten.</b>
--	---	--	---	---

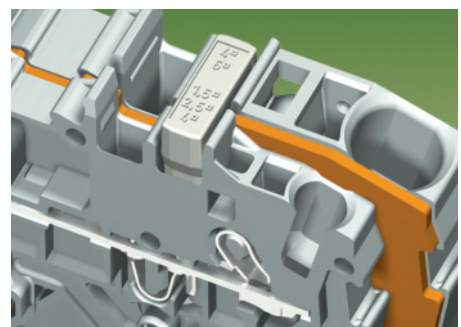
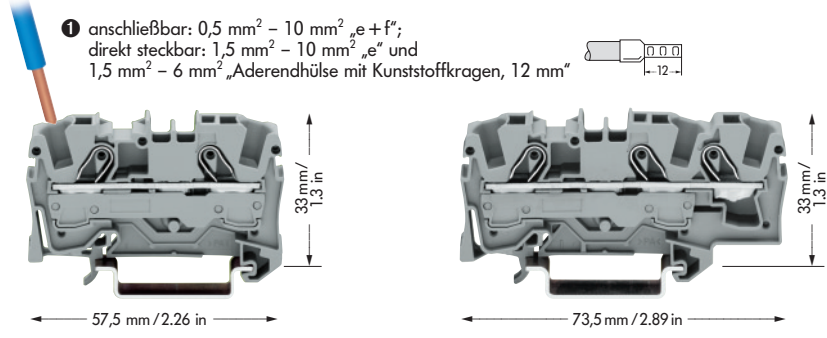

Bestell-Nr.	Stück je Verp.-Einh.	Bestell-Nr.	Stück je Verp.-Einh.	Bestell-Nr.	Stück je Verp.-Einh.
<b>2-Leiter-Durchgangsklemmen</b>		<b>3-Leiter-Durchgangsklemmen</b>		<b>Reduzierbrücken mit Reduzierbrücker</b>	
grau <b>2006-1201</b>	50	grau <b>2006-1301</b>	25	Beim Reduzierbrücken ist immer eine Abschlussplatte zwischen den zu brückenden Klemmen zu setzen.	
blau <b>2006-1204</b>	50	blau <b>2006-1304</b>	25	Der Reduzierbrücker 2006-499 ist für das Reduzierbrücken von 6/4 mm <sup>2</sup> auf 4/2,5/1,5 mm <sup>2</sup> geeignet.	
orange <b>2006-1202</b>	50	orange <b>2006-1302</b>	25		
<b>2-Leiter-Schutzleiterklemme</b>		<b>3-Leiter-Schutzleiterklemme</b>		Die Reduzierbrücker werden – wie auch bei den Kammbrückern üblich – von oben in die zu brückenden Klemmen bis zum Anschlag hineinsteckbar.	
grün-gelb <b>2006-1207</b>	50	grün-gelb <b>2006-1307</b>	25		
Ex e II-Anwendungen in Vorbereitung		Ex e II-Anwendungen in Vorbereitung			
Für Ex i-Anwendungen geeignet		Für Ex i-Anwendungen geeignet			

Zubehör		passende Beschriftungssysteme		WMB/Mini-WSB/Beschriftungsstreifen/WMB Inline (siehe Kapitel 14)	
<b>Abschluss- und Zwischenplatte, 1 mm dick</b>		<b>Abschluss- und Zwischenplatte, 1 mm dick</b>		<b>Reduzierbrücker, lichtgrau, isoliert</b>	
	orange <b>2006-1292</b> 100 (4 x 25)		orange <b>2006-1392</b> 100 (4 x 25)		32 A
	grau <b>2006-1291</b> 100 (4 x 25)		grau <b>2006-1391</b> 100 (4 x 25)		<b>2006-499</b> 50 (2 x 25)
<b>Kammbrücker, lichtgrau, isoliert, I<sub>N</sub> 41 A</b>		<b>Kammbrücker, lichtgrau, isoliert, I<sub>N</sub> 41 A</b>			
	2-fach <b>2006-402</b> 50 (2 x 25)		2-fach <b>2006-402</b> 50 (2 x 25)		
	3-fach <b>2006-403</b> 50 (2 x 25)		3-fach <b>2006-403</b> 50 (2 x 25)		
	4-fach <b>2006-404</b> 50 (2 x 25)		4-fach <b>2006-404</b> 50 (2 x 25)		
	5-fach <b>2006-405</b> 50 (2 x 25)		5-fach <b>2006-405</b> 50 (2 x 25)		
<b>Kammbrücker, lichtgrau, isoliert, I<sub>N</sub> 41 A</b>		<b>Kammbrücker, lichtgrau, isoliert, I<sub>N</sub> 41 A</b>			
	1 - 3 <b>2006-433</b> 50 (2 x 25)		1 - 3 <b>2006-433</b> 50 (2 x 25)		
	1 - 4 <b>2006-434</b> 50 (2 x 25)		1 - 4 <b>2006-434</b> 50 (2 x 25)		
	1 - 5 <b>2006-435</b> 50 (2 x 25)		1 - 5 <b>2006-435</b> 50 (2 x 25)		
<b>Warnabdeckung, mit schwarzem Blitzpfeil, für 5 Klemmen</b>		<b>Warnabdeckung, mit schwarzem Blitzpfeil, für 5 Klemmen</b>		<b>Reduzierbrücken mit Kammbrückern</b>	
	gelb <b>2006-115</b> 100 (4 x 25)		gelb <b>2006-115</b> 100 (4 x 25)	Das Reduzierbrücken über die offene Klemmenseite mit Abschlussplatte ist bei 6 / 4 und 2,5 mm <sup>2</sup> um einen Querschnitt kleiner möglich.	
<b>Prüfadapter, für Prüfstecker 4 mm Ø</b>		<b>Prüfadapter, für Prüfstecker 4 mm Ø</b>		Das Reduzierbrücken über die Klemmenrückwand mit Abschlussplatte ist um zwei Querschnitte kleiner möglich; z.B. 6 mm <sup>2</sup> auf 2,5 mm <sup>2</sup> (siehe rechte Abb.)	
	<b>2009-174</b> 100 (4 x 25)		<b>2009-174</b> 100 (4 x 25)		
<b>Prüfabgriff, für max. 2,5 mm<sup>2</sup></b>		<b>Prüfabgriff, für max. 2,5 mm<sup>2</sup></b>			
	<b>2009-182</b> 100 (4 x 25)		<b>2009-182</b> 100 (4 x 25)		
<b>Beschriftungsstreifen, weiß, unbedruckt, auf Spule für mittige Beschriftung</b>		<b>Beschriftungsstreifen, weiß, unbedruckt, auf Spule für mittige Beschriftung</b>			
	11 mm breit		11 mm breit		
	50 m <b>2009-110</b> 1		50 m <b>2009-110</b> 1		
	300 m <b>2009-130</b> 1		300 m <b>2009-130</b> 1		







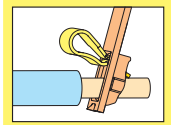









\* Weitere Prüfzeichen und zugeordnete Zulassungsdaten siehe Kapitel 15.











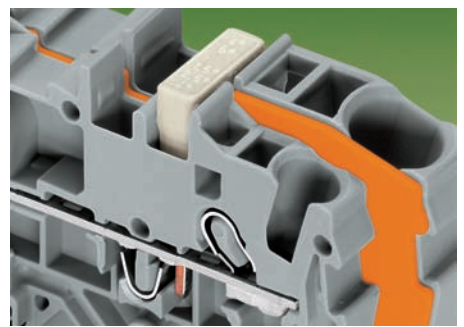
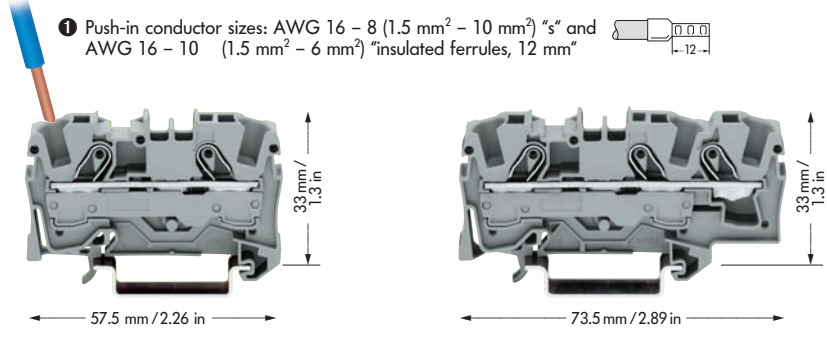























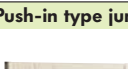
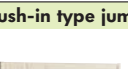

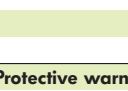
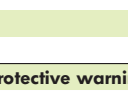

# TOPJOB<sup>®</sup> Rail-Mounted Terminal Blocks 6 (10) mm<sup>2</sup>/AWG 8 Series 2006



1  
9

<b>0.5 – 6 (10) mm<sup>2</sup> ①</b> 800 V/8 kV/3 41 A Terminal block width 7.5 mm / 0.295 in  13 – 15 mm / 0.55 in *    CCA LR	<b>AWG 20 – 8</b> 600 V, 50 A   600 V, 50 A  	<b>0.5 – 6 (10) mm<sup>2</sup> ①</b> 800 V/8 kV/3 41 A Terminal block width 7.5 mm / 0.295 in  13 – 15 mm / 0.55 in *    CCA LR	<b>AWG 20 – 8</b> 600 V, 50 A   600 V, 50 A  	<b>Commoning with step-down jumpers</b> Note: <b>The total current flowing must not exceed the rating of the step-down jumper/push-in type jumper bar.</b>
--	---	--	---	--



Item No.	Pack.-unit pcs	Item No.	Pack.-unit pcs	Item No.	Pack.-unit pcs
<b>2-conductor through terminal blocks</b>		<b>3-conductor through terminal blocks</b>		<b>Commoning with step-down jumpers</b>	
grey <b>2006-1201</b> 	50	grey <b>2006-1301</b> 	25	An end plate must be applied between the two terminal blocks.	
blue <b>2006-1204</b> 	50	blue <b>2006-1304</b> 	25	Step-down jumper 2006-499 can be used for commoning AWG 12/10 (4/6 mm <sup>2</sup> ) terminal blocks with AWG 12/14/16 (4/2.5/1.5 mm <sup>2</sup> ) terminal blocks.	
orange <b>2006-1202</b> 	50	orange <b>2006-1302</b> 	25	Step-down jumpers are simply pushed down to full insertion, in the same way as all other push-in type jumper bars.	
<b>2-conductor ground (earth) terminal block</b>		<b>3-conductor ground (earth) terminal block</b>			
green-yellow <b>2006-1207</b> 	50	green-yellow <b>2006-1307</b> 	25		
 Ex e II applications are being prepared		 Ex e II applications are being prepared			
 Suitable for Ex i applications		 Suitable for Ex i applications			
<b>Accessories</b> appropriate marker system <b>WMB/Miniature WSB/Marker strips</b> (see section 14)					
<b>End and intermediate plate, 1 mm/0.039 in thick</b>		<b>End and intermediate plate, 1 mm/0.039 in thick</b>		<b>Step-down jumper, light grey, insulated</b>	
 orange <b>2006-1292</b> 100 (4 x 25)		 orange <b>2006-1392</b> 100 (4 x 25)		 32 A	
 grey <b>2006-1291</b> 100 (4 x 25)		 grey <b>2006-1391</b> 100 (4 x 25)		<b>2006-499</b>	50 (2 x 25)
<b>Push-in type jumper bars, light grey, insulated, I<sub>N</sub> 41 A</b>		<b>Push-in type jumper bars, light grey, insulated, I<sub>N</sub> 41 A</b>			
 2-way <b>2006-402</b> 50 (2 x 25)		 2-way <b>2006-402</b> 50 (2 x 25)			
 3-way <b>2006-403</b> 50 (2 x 25)		 3-way <b>2006-403</b> 50 (2 x 25)			
 4-way <b>2006-404</b> 50 (2 x 25)		 4-way <b>2006-404</b> 50 (2 x 25)			
 5-way <b>2006-405</b> 50 (2 x 25)		 5-way <b>2006-405</b> 50 (2 x 25)			
<b>Push-in type jumper bars, light grey, insulated, I<sub>N</sub> 41 A</b>		<b>Push-in type jumper bars, light grey, insulated, I<sub>N</sub> 41 A</b>			
 1 - 3 <b>2006-433</b> 50 (2 x 25)		 1 - 3 <b>2006-433</b> 50 (2 x 25)			
 1 - 4 <b>2006-434</b> 50 (2 x 25)		 1 - 4 <b>2006-434</b> 50 (2 x 25)			
 1 - 5 <b>2006-435</b> 50 (2 x 25)		 1 - 5 <b>2006-435</b> 50 (2 x 25)			
<b>Protective warning marker, for 5 terminal blocks</b>		<b>Protective warning marker, for 5 terminal blocks</b>			
 yellow <b>2006-115</b> 100 (4 x 25)		 yellow <b>2006-115</b> 100 (4 x 25)			
<b>Test plug adapter, for test plug 4 mm/0.157 in Ø</b>		<b>Test plug adapter, for test plug 4 mm/0.157 in Ø</b>			
 <b>2009-174</b> 100 (4 x 25)		 <b>2009-174</b> 100 (4 x 25)			
<b>Testing tap, for max. 2.5 mm<sup>2</sup></b>		<b>Testing tap, for max. 2.5 mm<sup>2</sup></b>			
 <b>2009-182</b> 100 (4 x 25)		 <b>2009-182</b> 100 (4 x 25)			
<b>Marker strip, white, plain for center marking</b>		<b>Marker strip, white, plain for center marking</b>			
 11 mm/0.433 in wide		 11 mm/0.433 in wide			
50 m <b>2009-110</b>	1	50 m <b>2009-110</b>	1		
on roll 300 m <b>2009-130</b>	1	on roll 300 m <b>2009-130</b>	1		

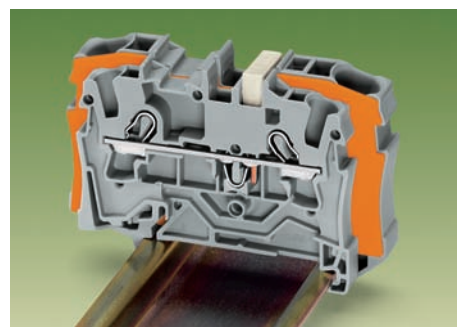

**Commoning with push-in type jumper bars**  
**Commoning over the open side of the terminal block with end plate** allows jumpering over one cross section size for 6 mm<sup>2</sup>, 4 mm<sup>2</sup> and 2.5 mm<sup>2</sup>.  
**Commoning over the closed side of the terminal block with end plate** allows jumpering over two cross section sizes: e.g. from 6 mm<sup>2</sup> to 2.5 mm<sup>2</sup> (see blue terminal blocks).

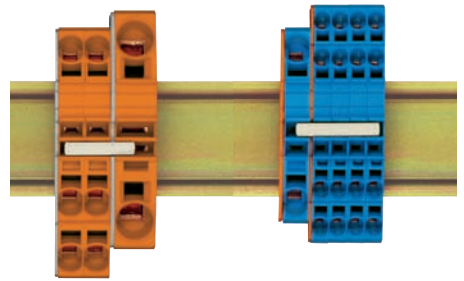

\* For further approvals with corresponding ratings see section 15.

# TOPJOB® S

## Bornes sur rail 6 (10) mm<sup>2</sup>

### Série 2006

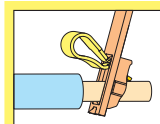

1  
9

<b>0,5 – 6 (10) mm<sup>2</sup> Ⓢ</b> 800 V/8 kV/3 41 A Largeur des bornes 7,5 mm / 0.295 in 13 – 15 mm / 0.55 in *     CCA LR	<b>AWG 20 – 8</b> 600 V, 50 A 600 V, 50 A	<b>0,5 – 6 (10) mm<sup>2</sup> Ⓢ</b> 800 V/8 kV/3 41 A Largeur des bornes 7,5 mm / 0.295 in 13 – 15 mm / 0.55 in *     CCA LR	<b>AWG 20 – 8</b> 600 V, 50 A 600 V, 50 A	<b>Pontage avec pont réducteur</b> Remarque : <b>D'une manière générale, le courant total des sorties ne doit pas dépasser le courant nominal du pont réducteur/peigne de pontage.</b>
--	---	--	---	--

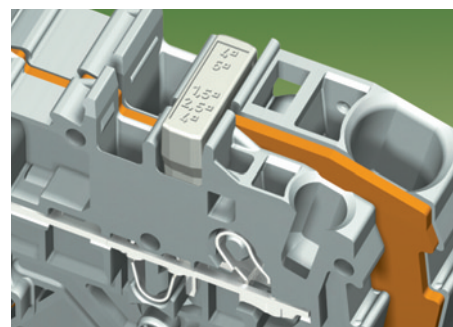
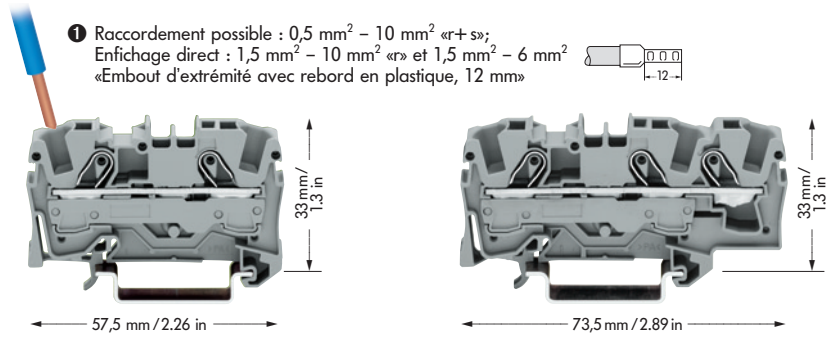

N° de produit	Unité d'emballage	N° de produit	Unité d'emballage	N° de produit	Unité d'emballage
<b>Bornes de passage pour 2 conducteurs</b>		<b>Bornes de passage pour 3 conducteurs</b>		<b>Pontage avec pont réducteur</b>	
gris 2006-1201	50	gris 2006-1301	25	Lors du pontage avec pont réducteur, il faut toujours prévoir une plaque d'extrémité entre les bornes à ponter.	
bleu 2006-1204	50	bleu 2006-1304	25	Le pont réducteur 2016-499 est prévu pour le pontage des bornes de 16/10 mm <sup>2</sup> à 10/6/4/2,5 mm <sup>2</sup> .	
orange 2006-1202	50	orange 2006-1302	25	Comme pour les peignes de pontage, les ponts réducteurs sont enfichés par le haut dans les bornes à ponter jusqu'à la butée.	
<b>Borne de protection pour 2 conducteurs</b>		<b>Borne de protection pour 3 conducteurs</b>			
vert-jaune 2006-1207	50	vert-jaune 2006-1307	25		
Ⓢ Applications Ex e II en préparation		Ⓢ Applications Ex e II en préparation			
② pour applications Ex i		② pour applications Ex i			

#### Accessoires

Système de marquage **WMB/Mini-WSB/Bandes de repérage** (voir chapitre 14)

<b>Plaque d'extrémité et intermédiaire, épaisseur 1 mm</b> orange 2006-1292 100 (4 x 25) gris 2006-1291 100 (4 x 25)	<b>Plaque d'extrémité et intermédiaire, épaisseur 1 mm</b> orange 2006-1392 100 (4 x 25) gris 2006-1391 100 (4 x 25)	<b>Pont réducteur, gris clair, isolé</b> 32 A 2006-499 50 (2 x 25)
<b>Peigne de pontage enfichable, gris clair, isolé, I<sub>N</sub> 41 A</b> 2 pôles 2006-402 50 (2 x 25) 3 pôles 2006-403 50 (2 x 25) 4 pôles 2006-404 50 (2 x 25) 5 pôles 2006-405 50 (2 x 25)	<b>Peigne de pontage enfichable, gris clair, isolé, I<sub>N</sub> 41 A</b> 2 pôles 2006-402 50 (2 x 25) 3 pôles 2006-403 50 (2 x 25) 4 pôles 2006-404 50 (2 x 25) 5 pôles 2006-405 50 (2 x 25)	
<b>Peigne de pontage enfichable, gris clair, isolé, I<sub>N</sub> 41 A</b> 1 - 3 2006-433 50 (2 x 25) 1 - 4 2006-434 50 (2 x 25) 1 - 5 2006-435 50 (2 x 25)	<b>Peigne de pontage enfichable, gris clair, isolé, I<sub>N</sub> 41 A</b> 1 - 3 2006-433 50 (2 x 25) 1 - 4 2006-434 50 (2 x 25) 1 - 5 2006-435 50 (2 x 25)	
<b>Couverture protectrice de signalisation de danger, pour 5 bornes</b> jaune 2006-115 100 (4 x 25)	<b>Couverture protectrice de signalisation de danger, pour 5 bornes</b> jaune 2006-115 100 (4 x 25)	<b>Pontage avec peignes de pontage</b> Le pontage avec ponts réducteurs par la face ouverte de la borne avec plaque d'extrémité est possible jusqu'à une section inférieure pour les bornes de 6 / 4 et 2,5 mm <sup>2</sup> . Le pontage avec ponts réducteurs par la face arrière de la borne avec plaque d'extrémité est possible jusqu'à deux sections inférieures; Ex. : de 6 mm <sup>2</sup> à 2,5 mm <sup>2</sup> (voir fig. à droite).
<b>Adaptateur de test, pour fiche de contrôle Ø 4 mm</b> 2009-174 100 (4 x 25)	<b>Adaptateur de test, pour fiche de contrôle Ø 4 mm</b> 2009-174 100 (4 x 25)	
<b>Prise de test pour 2,5 mm<sup>2</sup> max.</b> 2009-182 100 (4 x 25)	<b>Prise de test pour 2,5 mm<sup>2</sup> max.</b> 2009-182 100 (4 x 25)	
<b>Bandes de marquage, blanches, vierges, en rouleau pour marquage central</b> largeur 11 mm 50 m 2009-110 1 300 m 2009-130 1	<b>Bandes de marquage, blanches, vierges, en rouleau pour marquage central</b> largeur 11 mm 50 m 2009-110 1 300 m 2009-130 1	

\* Pour d'autres approbations avec les données techniques correspondantes, voir chapitre 15.